MultiSync FE770/FE771^{SB}



User's Manual

NEC

Declaration of the Manufacturer

We hereby certify that the colour monitor
MultiSync FE770/FE771^{SB} is in compliance with
Council Directive 73/23/EEC:

– EN 60950

Council Directive 89/336/EEC:

EN 55022

– EN 61000-3-2

– EN 61000-3-3

– EN 55024

and marked with



NEC-Mitsubishi Electric Visual
Systems Corporation
686-1, Nishioi Oi-Machi
Ashigarakami-gun
Kanagawa 258-8533, Japan

ENERGYSTAR Product

As an ENERGYSTAR Partner, NEC-Mitsubishi Electronics Display of America, Inc. has determined that this product meets the ENERGYSTAR guidelines for energy efficiency. The ENERGYSTAR emblem does not represent EPA endorsement of any product or service.

IBM is registered trademark of International Business Machines Corporation.

Apple and Macintosh are registered trademarks of Apple Computer Inc.

Microsoft and Windows are registered trademarks of the Microsoft Corporation.

ENERGYSTAR is a U.S. registered trademark.

NEC is a registered trademark of NEC Corporation.

All other trademarks or registered trademarks are property of their respective owners.



WARNING



TO PREVENT FIRE OR SHOCK HAZARDS, DO NOT EXPOSE THIS UNIT TO RAIN OR MOISTURE. ALSO, DO NOT USE THIS UNIT'S POLARIZED PLUG WITH AN EXTENSION CORD RECEPTACLE OR OTHER OUTLETS UNLESS THE PRONGS CAN BE FULLY INSERTED.
REFRAIN FROM OPENING THE CABINET AS THERE ARE HIGH VOLTAGE COMPONENTS INSIDE. REFER SERVICING TO QUALIFIED SERVICE PERSONNEL.



CAUTION



RISK OF ELECTRIC SHOCK • DO NOT OPEN

CAUTION: TO REDUCE THE RISK OF ELECTRIC SHOCK, DO NOT REMOVE COVER (OR BACK). NO USER SERVICE-ABLE PARTS INSIDE. REFER SERVICING TO QUALIFIED SERVICE PERSONNEL.



This symbol warns user that uninsulated voltage within the unit may have sufficient magnitude to cause electric shock. Therefore, it is dangerous to make any kind of contact with any part inside this unit.



This symbol alerts the user that important literature concerning the operation and maintenance of this unit has been included. Therefore, it should be read carefully in order to avoid any problems.

Canadian Department of Communications Compliance Statement

DOC: This Class B digital apparatus meets all requirements of the Canadian Interference-Causing Equipment Regulations.

C-UL: Bears the C-UL Mark and is in compliance with Canadian Safety Regulations according to C.S.A. C22.2 No. 950.

FCC Information

1. Use the attached specified cables with the MultiSync FE colour monitor so as not to interfere with radio and television reception.
 - (1) Please use the supplied power cord or equivalent to ensure FCC compliance.
 - (2) Shielded captive type signal cable.
Use of other cables and adapters may cause interference with radio and television reception.
2. This equipment has been tested and found to comply with the limits for a Class B digital device, pursuant to part 15 of the FCC Rules. These limits are designed to provide reasonable protection against harmful interference in a residential installation. This equipment generates, uses, and can radiate radio frequency energy, and, if not installed and used in accordance with the instructions, may cause harmful interference to radio communications. However, there is no guarantee that interference will not occur in a particular installation. If this equipment does cause harmful interference to radio or television reception, which can be determined by turning the equipment off and on, the user is encouraged to try to correct the interference by one or more of the following measures:
 - Reorient or relocate the receiving antenna.
 - Increase the separation between the equipment and receiver.
 - Connect the equipment into an outlet on a circuit different from that to which the receiver is connected.
 - Consult your dealer or an experienced radio/TV technician for help.

Changes or modifications not expressly approved by the party responsible for compliance could void the user's authority to operate the equipment.

If necessary, the user should contact the dealer or an experienced radio/television technician for additional suggestions. The user may find the following booklet, prepared by the Federal Communications Commission, helpful: "How to Identify and Resolve Radio-TV Interference Problems." This booklet is available from the U.S. Government Printing Office, Washington, D.C., 20402, Stock No. 004-000-00345-4.

Contents

Your new NEC MultiSync FE monitor box* should contain the following:

- MultiSync FE Monitor with tilt/swivel base
- Power Cord
- Captive Signal Cable
- User's Manual
- CD ROM with Setup Software, complete User's Manual and other helpful files.
To see the User's Manual, Acrobat Reader 4.0 must be installed on your PC.

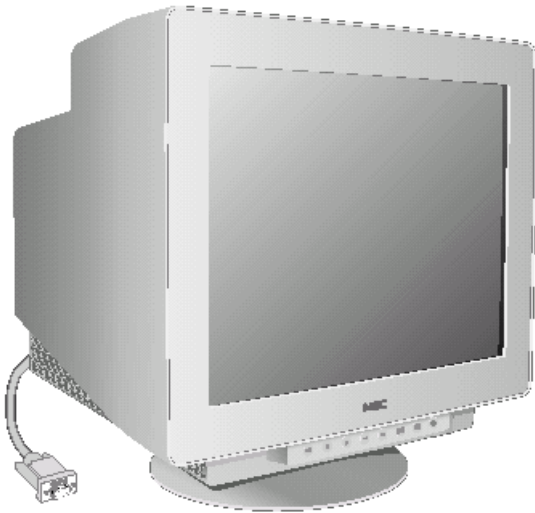

Captive Signal Cable

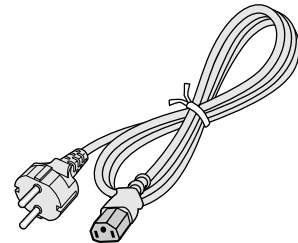

Power Cord

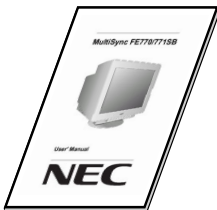

User's Manual



Sales Office List

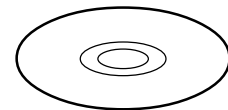

CD-ROM

** Remember to save your original box and packing material to transport or ship the monitor.*

Quick Start

To attach the FE monitor to your system, follow these instructions:

1. Turn off the power to your computer.
2. If necessary, install the display card into your system. For more information, refer to the display card manual.
3. For the PC: Connect the 15-pin mini D-SUB of the captive signal cable to the connector of the display card in your system (**Figure A.1**). Tighten all screws.

For the Mac: Connect the MultiSync FE Macintosh cable adapter (not included) to the monitor connector on the Macintosh (**Figure B.1**). Attach the 15-pin mini D-SUB end of the captive signal cable to the MultiSync FE Macintosh cable adapter on the computer (**Figure B.1**). Tighten all screws.

4. Connect one end of the power cord to the MultiSync FE monitor and the other end to the power outlet (**Figure C.1**).
5. Turn on the monitor (**Figure D.1**) and the computer.

NOTE: If you have any problems, please refer to the **Troubleshooting** section of this User's Manual.

Figure A.1

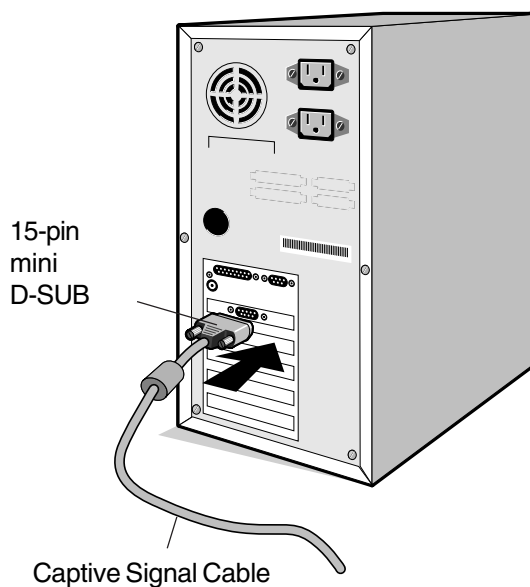
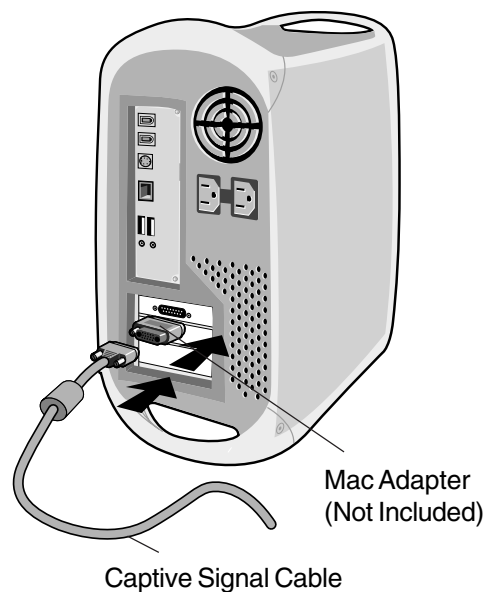

Figure B.1



Quick Start – *continued*

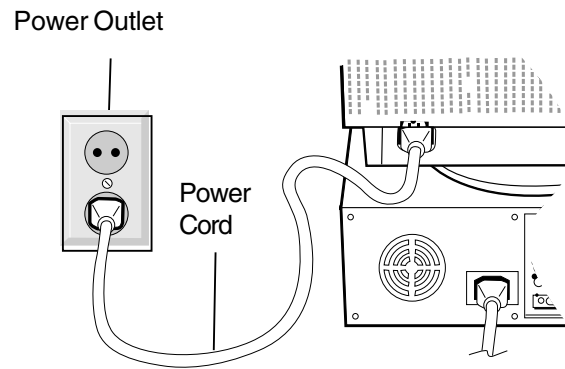

Figure C.1



Figure D.1

Controls

OSM (On-Screen Manager) control buttons on the front of the monitor function as follows:

	Main Menu	Sub-Menu
EXIT	Exits the OSM menu.	Exits to the OSM controls main menu.
CONTROL ◀/▶	Moves the highlighted area left/right to select one of the sub-menus.	Moves the highlighted area left/right to select one of the controls.
CONTROL -/+	Has no function.	Moves the bar in the – or + direction to decrease or increase the adjustment.
SELECT (FE770)	Enters sub-menu.	Has no function.
SELECT/ SBMODE (FE771SB)	Without OSD, switches SuperBright Mode ON/OFF With OSD, enters sub menu	Has no function.
RESET	Resets all the controls within the highlighted menu to the factory setting.	Resets the highlighted control to the factory setting.

NOTE: When **RESET** is pressed in the main and sub-menu, a warning window will appear allowing you to cancel the reset function.

NOTE: In SB MODE (SuperBright Mode, FE771SB only), ON and OFF is functional when the OSM is not displayed.

Brightness/Contrast Controls

Brightness: Adjusts the overall image and background screen brightness.

Contrast: Adjusts the image brightness in relation to the background.

Degauss: Eliminates the buildup of stray magnetic fields which alter the correct scan of the electron beams and affect the purity of the screen colours, focus and convergence. When activated, your screen image will jump and waver a bit as the screen is demagnetized.

Caution: Please allow a minimum of 20 minutes to elapse between uses of the Degauss Control.

Size and Position Controls

Left/Right: Moves the image horizontally (left or right).

Down/Up: Moves the image vertically (up or down).

Narrow/Wide: Decreases or increases the horizontal size of the image.

Short/Tall: Decreases or increases the vertical size of the image.

Controls – continued

Color Control System

Colour presets selects the desired colour setting. The bar is replaced by the colour setting choice. Each colour setting is adjusted at the factory to the stated Kelvin. If a setting is adjusted, the name of the setting will change from Kelvin to Custom except sRGB mode.

Red, Green, Blue: Color Control System decreases or increases the monitor's red, green or blue colour guns depending upon which is selected. The change in colour will appear on screen and the direction (decrease or increase) will be shown by the bars.

sRGB mode: sRGB mode provides the suitable colour managed picture image. You can not change Red, Green and Blue colours, brightness and contrast individually.

Colour Temperature Adjustment: Adjusts the colour temperature of the screen image.

Geometry Controls

Geometry Controls Menu

The **Geometry** controls allow you to adjust the curvature or angle of the sides of your display.

Sides In/Out (pincushion): Decreases or increases the curvature of the sides either inward or outward.

Sides Left/Right (pincushion balance): Decreases or increases the curvature of the sides either to the left or right.

Sides Tilt (parallelogram): Decreases or increases the tilt of the sides either to the left or right.

Sides Align (trapezoidal): Decreases or increases the bottom of the screen to be the same as the top.

Rotate (raster rotation): Rotates the entire display clockwise or counterclockwise.

Tools 1

Moiré Canceler: Moiré is a wavy pattern which can sometimes appear on the screen. The pattern is repetitive and superimposed as rippled images. When running certain applications, the wavy pattern is more evident than in others. To reduce moiré, adjust the level by using –/+ CONTROL buttons.

Tools 2

Language: OSM controls menus are available in 6 languages.

OSM Position: You can choose where you would like the OSM controls menu to appear on your screen. Selecting OSM Position allows you to manually adjust the OSM controls menu position from among Center, Top left, Top right, Bottom left and Bottom right.

OSM Turn Off: The OSM controls menu will stay on as long as it is in use. In the OSM Turn Off sub-menu, you can select how long the monitor waits after the last touch of a button for the OSM controls menu to disappear. The preset choices are 5 thru 120 seconds.

Controls – continued

OSM Lock Out: This control completely locks out access to all OSM controls functions except Brightness and Contrast. When attempting to activate OSM controls while in the lock out mode, a screen will appear indicating that OSM controls are locked out. To activate the OSM Lock Out function, press SELECT and hold + down simultaneously. To deactivate the OSM Lock Out, press SELECT and hold + down simultaneously.

IPM System Off Mode:

Enable:	The IPM System works normally and all stages of energy savings are utilized.
Disable:	The Off Mode of the IPM System is not used.

NOTE: For standard systems and graphics boards, keep the factory setting at ENABLE.

Factory Preset: Selecting Factory Preset allows you a reset most OSM control settings back to the factory settings. A warning statement will appear to confirm that you do want to reset ALL settings. Individual settings can be reset by highlighting the control to be reset and pressing the **RESET** button.



Information

Display Mode: Indicates the current mode and frequency setting of the monitor.

Monitor Info: Indicates the model and serial numbers of your monitor.

Refresh Notifier: A message will advise you if the refresh rate of the signal being applied to the monitor by the computer is too low. For further information, please refer to your display card or system manual.

Recommended Use

Safety Precautions and Maintenance



FOR OPTIMUM PERFORMANCE, PLEASE NOTE THE FOLLOWING WHEN SETTING UP AND USING THE MULTISYNC FE COLOUR MONITOR:



- DO NOT OPEN THE MONITOR. There are no user serviceable parts inside and opening or removing covers may expose you to dangerous shock hazards or other risks. Refer all servicing to qualified service personnel.
- Do not spill any liquids into the cabinet or use your monitor near water.
- Do not insert objects of any kind into the cabinet slots, as they may touch dangerous voltage points, which can be harmful or fatal or may cause electric shock, fire or equipment failure.
- Do not place any heavy objects on the power cord. Damage to the cord may cause shock or fire.
- Do not place this product on a sloping or unstable cart, stand or table, as the monitor may fall, causing serious damage to the monitor.
- Keep the monitor away from high capacity transformers, electric motors and other devices such as external speakers or fans, which may create strong magnetic fields.
- If possible, position the monitor so that it is facing the east to minimize the effects of the earth's magnetic field.
- Changing the direction of the monitor while it is powered on may cause image discolouration. To correct this, turn the monitor off for 20 minutes before powering it back on.
- When operating the MultiSync FE with its AC 220 - 240 V worldwide power supply, use a power supply cord that matches the power supply voltage of the AC power outlet being used. The power supply cord you use must have been approved by and comply with the safety standards of your country. (Type H05VV-F should be used except in UK)
- In UK, use a BS-approved power cord with molded plug having a black (5A) fuse installed for use with this monitor. If a power cord is not supplied with this monitor, please contact your supplier.

Cleaning Your Monitor

A special coating is provided on the glass (CRT) surface of this monitor to reduce a reflection and static electricity on the glass surface. Due to the delicate coating on the glass surface, use a lint-free, non-abrasive cloth (cotton or equivalent) and a non-alcohol, neutral, non-abrasive cleaning solution to minimize dust. If the screen requires more than a light cleaning, apply a soft neutral detergent and water directly to a soft cloth and use it upon wringing water, to clean the glass surface. Clean your monitor regularly.

CAUTION: The following agents will cause damage to the CRT when cleaning the glass surface:

Benzene, thinner, acid/alkaline detergent, alcohol detergent, detergent with abrasive powder, detergent with anti-static agent, detergent for cleaning.

Immediately unplug your monitor from the wall outlet and refer servicing to qualified service personnel under the following conditions:

- When the power supply cord or plug is damaged.
- If liquid has been spilled, or objects have fallen into the monitor.
- If the monitor has been exposed to rain or water.
- If the monitor has been dropped or the cabinet damaged.
- If the monitor does not operate normally by following operating instructions.
 - Allow adequate ventilation around the monitor so that heat can properly dissipate. Do not block ventilated openings or place the monitor near a radiator or other heat sources. Do not put anything on top of monitor.
 - The power cable connector is the primary means of detaching the system from the power supply. The monitor should be installed close to a power outlet which is easily accessible.
 - Handle with care when transporting. Save packaging for transporting.



CAUTION

Recommended Use – continued



CORRECT PLACEMENT AND ADJUSTMENT OF THE MONITOR CAN REDUCE EYE, SHOULDER AND NECK FATIGUE. CHECK THE FOLLOWING WHEN YOU POSITION THE MONITOR:



- Adjust the monitor height so that the top of the screen is at or slightly below eye level. Your eyes should look slightly downward when viewing the middle of the screen.
- Position your monitor no closer than 40 cm and no further away than 60 cm from your eyes. The optimal distance is 50 cm.
- Rest your eyes periodically by focusing on an object at least 6 meter away. Blink often.
- Position the monitor at a 90° angle to windows and other light sources to minimize glare and reflections. Adjust the monitor tilt so that ceiling lights do not reflect on your screen.
- If reflected light makes it hard for you to see your screen, use an anti-glare filter.
- Clean your monitor regularly. Use a lint-free, non-abrasive cloth and a non-alcohol, neutral, non-abrasive cleaning solution or glass cleaner to minimize dust.
- Adjust the monitor's brightness and contrast controls to enhance readability.
- Use a document holder placed close to the screen.
- Position whatever you are looking at most of the time (the screen or reference material) directly in front of you to minimize turning your head while you are typing.
- Get regular eye checkups.

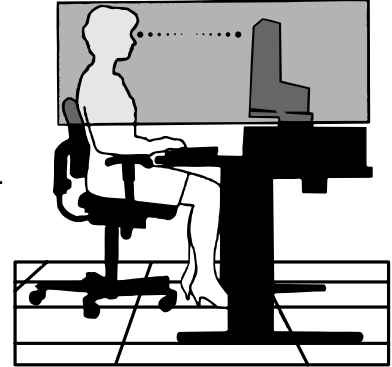

Ergonomics

To realize the maximum ergonomics benefits, we recommend the following:

- Adjust the Brightness until the background raster disappears
- Do not position the Contrast control to its maximum setting
- Use the preset Size and Position controls with standard signals
- Use the preset Colour Setting and Sides Left/Right controls
- Use non-interlaced signals with a vertical refresh rate between 75 - 120 Hz
- Do not use primary colour blue on a dark background, as it is difficult to see and may produce eye fatigue due to insufficient contrast

Specifications

Monitor Specifications	MultiSync FE770 Monitor	Notes
Picture Tube Viewable Image Size:	Diagonal: 43 cm/17 inch 406 mm/16 inch	90° deflection, 0.21 - 0.25 mm variable (horizontal) dot pitch, 0.24 - 0.28 mm variable (diagonal) dot pitch, medium short persistence phosphor, multi-layered, anti-static screen coating, semi-tint screen, Invar Shadow Mask and OptiClear screen.
Input Signal	Video: ANALOG 0.7 Vp-p/75 Ohms Sync: Separate sync. TTL Level Horizontal sync. Positive/Negative Vertical sync. Positive/Negative Composite sync. (Positive/Negative) (TTL Level)	
Display Colours	Analog input: Unlimited number of Colours	Depends on display card used.
Synchronization	Horizontal: 30 kHz to 70 kHz	Automatically
Range	Vertical: 50 Hz to 120 Hz	Automatically
Resolutions Supported Resolution based on horizontal and vertical frequencies only	640 x 480 @ 60 to 120 Hz 800 x 600 @ 50 to 110 Hz 832 x 624 @ 50 to 106 Hz 1024 x 768 @ 50 to 87 Hz 1152 x 864 @ 50 to 77 Hz 1280 x 1024 @ 50 to 66 Hz	Some systems may not support all modes listed. NEC-Mitsubishi Electronics Display cites recommended resolution at 85 Hz for optimal display performance
Active Display Area (Factory Setting)	Horizontal: 315 mm/12.4 inches Vertical: 236 mm/9.3 inches	Dependent upon signal timing used, and does not include border area.
Active Display Area (Full Scan)	325 mm/12.8 inches 244 mm/9.6 inches	Dependent upon signal timing used, and does not include border area.
Power Supply	AC 100 - 240 V, 50 - 60 Hz	
Current Rating	1.5A @ 100 - 240 V	
Dimensions	397 mm (W) x 392 mm (H) x 415.5 mm (D) 15.6 inches (W) x 15.4 inches (H) x 16.4 inches (D)	
Weight	16.0 kg 35.3 lbs	
Environmental Considerations		
	Operating Temperature: +5 °C to +35 °C Humidity: 10 % to 90 % Altitude: 0 to 3,000 m Storage Temperature: -20 °C to +60 °C Humidity: 10 % to 90 % Altitude: 0 to 15,000 m	

NOTE: Technical specifications are subject to change without notice.

Specifications – continued

Monitor Specifications	MultiSync FE771SB Monitor	Notes
Picture Tube Viewable Image Size:	Diagonal: 43 cm/17 inch 406 mm/16 inch	90° deflection, 0.25 mm grille pitch, medium short persistence phosphor, aperture grille CRT, multi-layered, anti-static screen coating, dark-tint screen and OptiClear screen.
Input Signal	Video: ANALOG 0.7 Vp-p/75 Ohms Sync: Separate sync. TTL Level Horizontal sync. Positive/Negative Vertical sync. Positive/Negative Composite sync. (Positive/Negative) (TTL Level)	
Display Colours	Analog input: Unlimited number of Colours	Depends on display card used.
Synchronization	Horizontal: 30 kHz to 70 kHz	Automatically
Range	Vertical: 50 Hz to 120 Hz	Automatically
Resolutions Supported Resolution based on horizontal and vertical frequencies only	640 x 480 @ 60 to 120 Hz 800 x 600 @ 50 to 110 Hz 832 x 624 @ 50 to 106 Hz 1024 x 768 @ 50 to 87 Hz 1152 x 864 @ 50 to 77 Hz 1280 x 1024 @ 50 to 66 Hz	Some systems may not support all modes listed. NEC-Mitsubishi Electronics Display cites recommended resolution at 85 Hz for optimal display performance
Active Display Area (Factory Setting)	Horizontal: 315 mm/12.4 inches Vertical: 236 mm/9.3 inches	Dependent upon signal timing used, and does not include border area.
Active Display Area (Full Scan)	325 mm/12.8 inches 244 mm/9.6 inches	Dependent upon signal timing used, and does not include border area.
Power Supply	AC 100 - 240 V, 50 - 60 Hz	
Current Rating	1.5A @ 100 - 240 V	
Dimensions	397 mm (W) x 392 mm (H) x 415.5 mm (D) 15.6 inches (W) x 15.4 inches (H) x 16.4 inches (D)	
Weight	16.8 kg 37.0 lbs	
Environmental Considerations		
	Operating Temperature: +5 °C to +35 °C Humidity: 10 % to 90 % Altitude: 0 to 3,000 m Storage Temperature: -20 °C to +60 °C Humidity: 10 % to 90 % Altitude: 0 to 15,000 m	

NOTE: Technical specifications are subject to change without notice.

Features

ClearFlat Shadow Mask CRT (FE770): Delivers an outstanding viewing experience with a virtually flat image, eliminating distortion and reducing glare so that what you see on-screen is as realistic and lifelike as what you see on your printed output. The patented ClearFlat CRT also offers a high contrast screen with a fine 0.21 - 0.25 mm horizontal dot pitch, delivering crisp, clean text and graphics.

SuperBright Diamondtron CRT (FE771^{SB}): This patented flat aperture grille CRT delivers an exceptional viewing experience with unprecedented brightness and contrast and a virtually flat image that reduces distortion and glare so that what you see on-screen is what you get on your printed output. The state-of-the-art Mitsubishi PX-DBF electron gun and tight 0.25 mm grille pitch delivers precise focus for crisp, clear text and images.

SuperBright Mode (FE771^{SB}): With the simple touch of a button, the brightness level of the Diamondtron CRT doubles. This function enhances the crispness of images for clarity-conscious applications such as graphics, animation and video

OptiClear Screen Surface: Further reduces reflection and glare and increases contrast without sacrificing focus level, clarity or brightness.

Dual Dynamic Beam Focus: Provides precise, continuous focus adjustments of the electron beams and optimum image quality, even to the far edges of the screen.

Color Control System with sRGB: Allows you to change between five colour settings on your display to match your personal preference. The sRGB-enabled colour matching setting found within Color Control helps achieve a consistent colour environment with other sRGB-enabled hardware and software applications.

On Screen Manager (OSM) Controls: Allows you to quickly and easily adjust all elements of your screen image via simple to use on-screen menus.

ErgoDesign Features: Enhances human ergonomics to improve the working environment, protect the health of the user and save money. Examples include OSM controls for quick and easy image adjustments, tilt/swivel base for preferred angle of vision, space-conscious cabinet design and compliance with MPRII guidelines for lower emissions.

Plug and Play: The Microsoft solution with the Windows 95/98/Me/2000/XP operating system facilitates setup and installation by allowing the monitor to send its capabilities (such as screen size and resolutions supported) directly to your computer, automatically optimizing display performance.

Intelligent Power Manager (IPM) System: Provides innovative power-saving methods that allow the monitor to shift to a lower power consumption level when on but not in use, saving two-thirds of your monitor energy costs, reducing emissions and lowering the air conditioning costs of the workplace.

Features – *continued*

Reduced Magnetic Field Technology: Reduces magnetic and alternating electric field emissions and static electricity, addressing ergonomic concerns regarding potential risks from extended computer monitor use.

Multiple Frequency Technology: Automatically adjusts monitor to the display card's scanning frequency, thus displaying the resolution required.

FullScan Capability: Allows you to use the entire screen area in most resolutions, significantly expanding image size.

Troubleshooting

No picture

- Display card should be completely seated in its slot.
- Power Button and computer power switch should be in the ON position.
- Signal cable should be completely connected to display card/computer.
- Check connector for bent or pushed-in pins.

Image is scrolling or unstable

- Signal cable should be completely attached to the computer.
- Check pin assignments and signal timings of the monitor and your display card with respect to recommended timings and pin assignments.
- If the Macintosh cable adapter is used, check for proper connection or make sure the display card is Macintosh compatible and that the card is properly seated in the computer.

LED on monitor is not lit (*no green, orange colour can be seen*)

- Power Switch should be in the ON position and power cord should be connected.

Picture is fuzzy or colour looks blotchy

- Adjust Brightness and Contrast Controls or adjust the Moiré Canceler control.
- Access the Degauss Control through OSM controls. Activate the Degauss Control.
CAUTION: A minimum interval of 20 minutes should elapse before the Degauss Control is used a second time when not switching between modes.

Picture bounces or a wavy pattern is present in the picture

- Move electrical devices that may be causing electrical interference away from the monitor.
- See inside cover of User's Manual for FCC information.

Edges of the display image are not square

- Use the OSM Geometry Controls to straighten the edges.
- If possible, position the front of the monitor facing east.

Display image is not centered, too small, or too large

- Use the OSM Size and Position Controls to adjust the image.

Thin lines appear on your screen

- Thin lines are normal for an aperture grille CRT and are not a malfunction.
These are shadows from the damper wires used to stabilize the aperture grille and are most noticeable when the screen's background is light (usually white).

Black vertical lines are visible on the screen

- Thin vertical black lines on one or both sides of the screen. This minor condition is caused by grille element overlap which can occur during shipping.
- Position an open white window over the affected area of the screen and maximize the brightness and contrast controls. This will cause localized heating of the overlap which will clear in a few minutes. Be sure to readjust the brightness and contrast controls back to the normal viewing level after this procedure.

TCO'99

MultiSync FE Series

Congratulations! You have just purchased a TCO'99 approved and labeled product! Your choice has provided you with a product developed for professional use. Your purchase has also contributed to reducing the burden on the environment and also to the further development of environmentally adapted electronics products.



Why do we have environmentally labelled computers?

In many countries, environmental labelling has become an established method for encouraging the adaptation of goods and services to the environment. The main problem, as far as computers and other electronics equipment are concerned, is that environmentally harmful substances are used both in the products and during the manufacturing. Since it has not been possible for the majority of electronics equipment to be recycled in a satisfactory way, most of these potentially damaging substances sooner or later enter Nature.

There are also other characteristics of a computer, such as energy consumption levels, that are important from the viewpoints of both the work (Internal) and natural (external) environments. Since all methods of conventional electricity generation have a negative effect on the environment (acidic and climate-influencing emissions, radioactive waste, etc.), it is vital to conserve energy. Electronics equipment in offices consume an enormous amount of energy since they are often left running continuously.

What does labelling involve?

This product meets the requirements for the TCO'99 scheme which provides for international and environmental labelling of personal computers. The labelling scheme was developed as a joint effort by the TCO (The Swedish Confederation of Professional Employees), Svenska Naturskyddsforeningen (The Swedish Society for Nature Conservation) and Statens Energimyndighet (The Swedish National Energy Administration).

The requirements cover a wide range of issues: environment, ergonomics, usability, emission of electrical and magnetic fields, energy consumption and electrical and fire safety.

The environmental demands concern restrictions on the presence and use of heavy metals, brominated and chlorinated flame retardants, CFCs (freons) and chlorinated solvents, among other things. The product must be prepared for recycling and the manufacturer is obliged to have an environmental plan which must be adhered to in each country where the company implements its operational policy. The energy requirements include a demand that the computer and/or display, after a certain period of inactivity, shall reduce its power consumption to a lower level in one or more stages. The length of time to reactivate the computer shall be reasonable for the user.

Labelled products must meet strict environmental demands, for example, in respect of the reduction of electric and magnetic fields, physical and visual ergonomics and good usability.

Environmental Requirements

Flame retardants

Flame retardants are present in printed circuit boards, cables, wires, casings and housings. In turn, they delay the spread of fire. Up to thirty percent of the plastic in a computer casing can consist of flame retardant substances. Most flame retardants contain bromine or chloride and these are related to another group of environmental toxins, PCBs, which are suspected to give rise to severe health effects, including reproductive damage in fish-eating birds and mammals, due to the bioaccumulative* processes. Flame retardants have been found in human blood and researchers fear that disturbances in foetus development may occur.

TCO'99 – *continued*

TCO'99 demand requires that plastic components weighing more than 25 grams must not contain flame retardants with organically bound chlorine and bromine. Flame retardants are allowed in the printed circuit boards since no substitutes are available.

Lead**

Lead can be found in picture tubes, display screens, solders and capacitors. Lead damages the nervous system and in higher doses, causes lead poisoning.

TCO'99 requirement permits the inclusion of lead since no replacement has yet been developed.

Cadmium**

Cadmium is present in rechargeable batteries and in the colourgenerating layers of certain computer displays. Cadmium damages the nervous system and is toxic in high doses.

TCO'99 requirement states that batteries, the colourgenerating layers of display screens and the electrical or electronics components must not contain any cadmium.

Mercury**

Mercury is sometimes found in batteries, relays and switches, Mercury damages the nervous system and is toxic in high doses.

TCO'99 requirement states that batteries may not contain any Mercury. It also demands that no mercury is present in any of the electrical or electronics components associated with the display unit.

CFCs (freons)

CFCs (freons) are sometimes used for washing printed circuit boards. CFCs break down ozone and thereby damage the ozone layer in the stratosphere, causing increased reception on Earth of ultraviolet light with consequent increased risks of skin cancer (malignant melanoma).

The relevant TCO'99 requirement; Neither CFCs nor HCFCs may be used during the manufacturing and assembly of the product or its packaging.

* Bio-accumulative is defined as substances which accumulate within living organisms.

** Lead, Cadmium and Mercury are heavy metals which are Bio-accumulative.

To obtain complete information on the environmental criteria document, order from:

TCO Development Unit
SE-114 94 Stockholm
SWEDEN
FAX Number: +46 8 782 92 07
E-mail (Internet): development@tco.se

You may also obtain current information on TCO'99 approved and labelled products by visiting their website at:
<http://www.tco-info.com/>